

TiLite ONLY Clamp/Angle Adjust Footrest: Special Instructions

With a TiLite ONLY Clamp/Angle Adjust footrest it is CRITICAL to have the correct clamp. If you try to force the FreeWheel to attach to an incorrect TiLite clamp, your FreeWheel can be damaged. Part 102 comes with the correct clamp, shim and pinning screws.

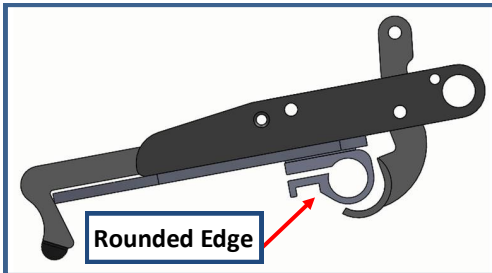

CORRECT TiLite Clamp

If your TiLite clamp looks like the clamp to the left, with a rounded bottom curve, you will only need a shim and pinning screws.

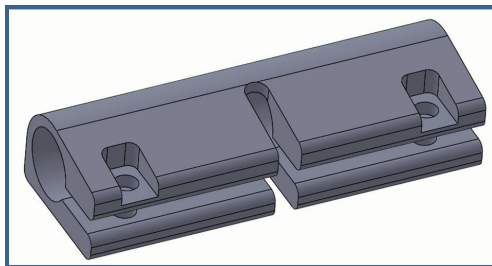
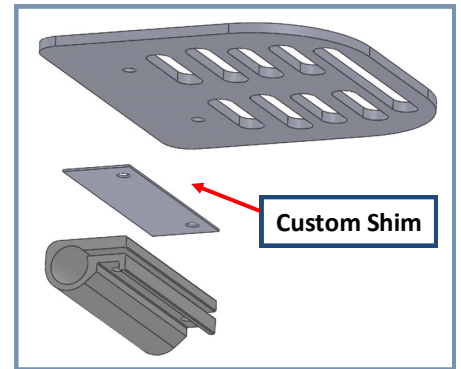

If your TiLite clamp looks like the clamp to the left, this will NOT WORK and you will need to order Part P102, which includes a clamp, shim and pinning screws.

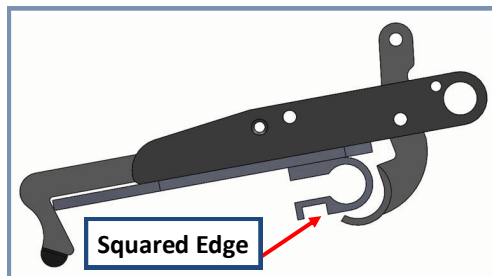

If your TiLite clamp looks like the clamp to the left, with a squared edge at the bottom, you will need to either replace it with Part P102 or use a Dremel and remove material and curve the bottom (see picture on right).

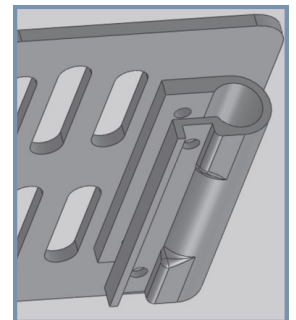

Pinning Instructions for Clamp Plate/Angle Adjust Footrests

To make sure your Clamp Plate/Angle Adjust footrest does not rotate you will need to add 2 screws to lock the clamp holding your footrest plate to your tube. Use two #10-32 Self Threading machine screws, centered, and 3" apart.

Make pilot holes with a 5/32" drill bit. Using a lubricant such as WD40 helps with inserting the screw to lock the clamp (screws only needs to go through front of tube). Maximum plate angle down is 12 degrees.

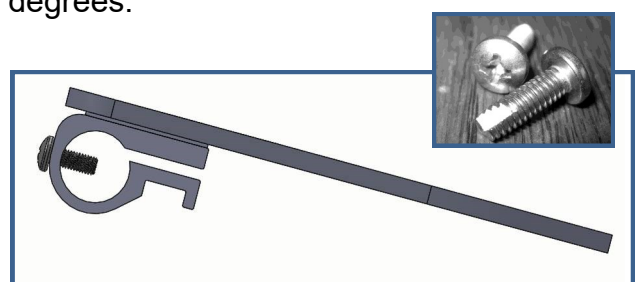
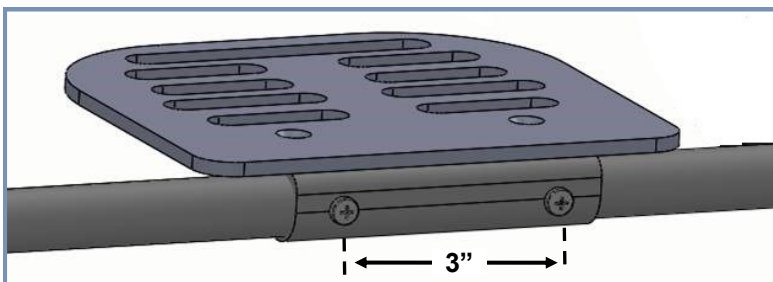

You may reach us at info@gofreewheel.com if you have any questions.